

3031 Z / 40 / 2013

# 3031 Z / 40 / 2013

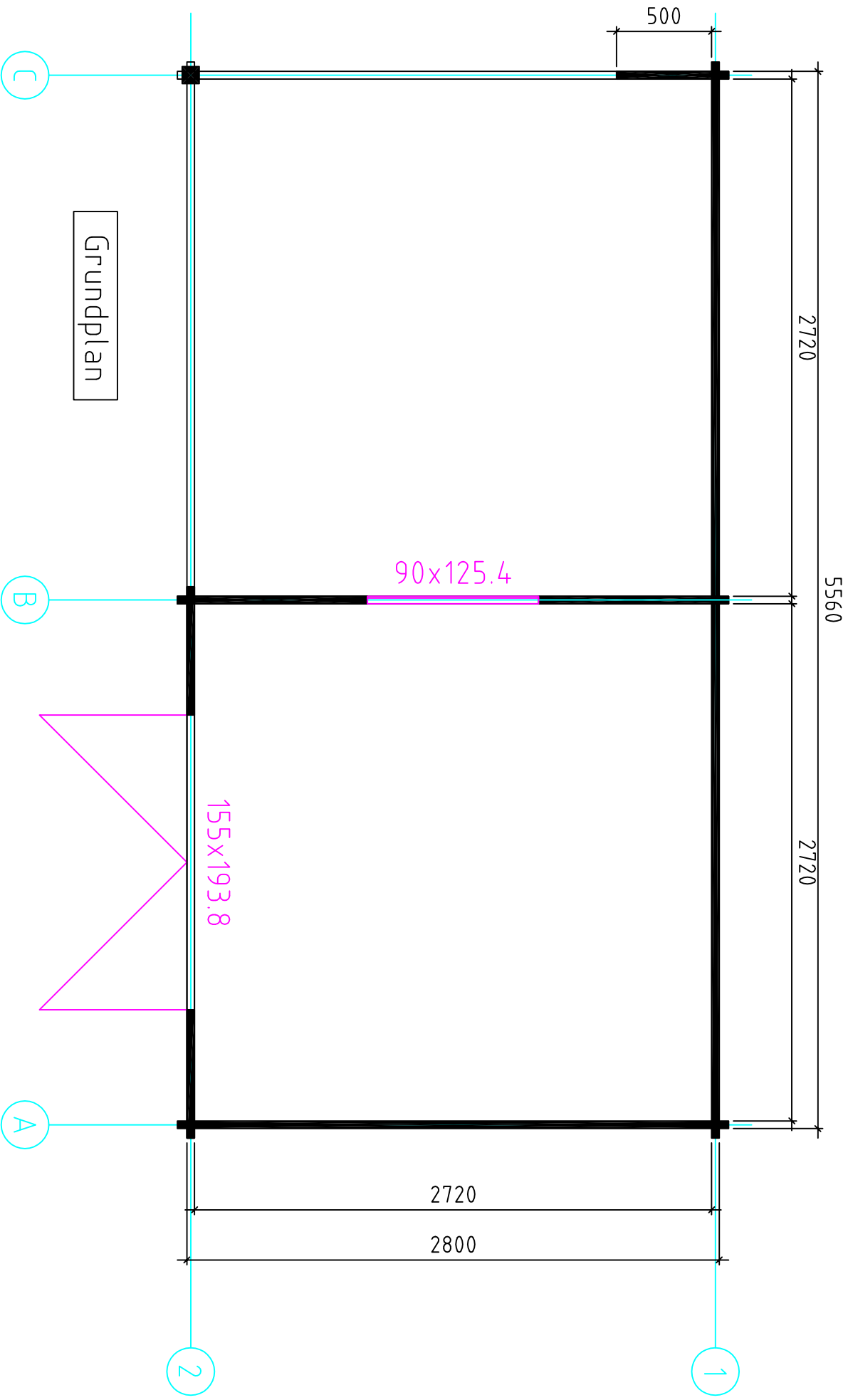

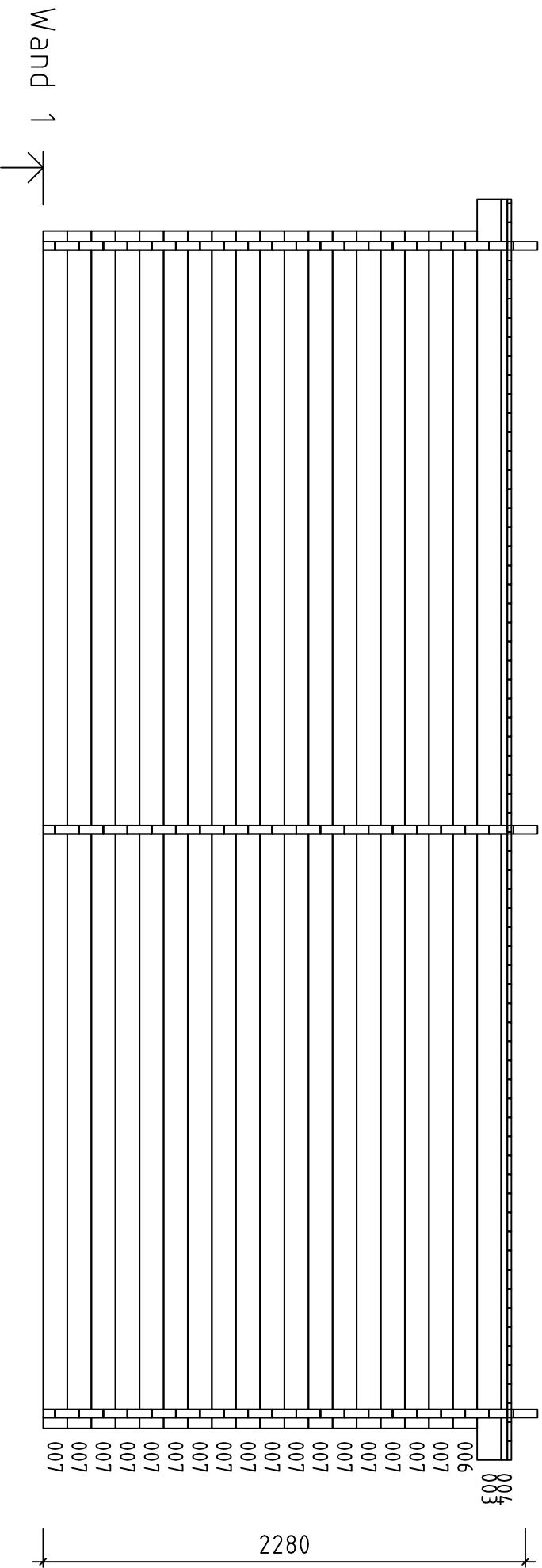

3031 Z / 40 / 2013

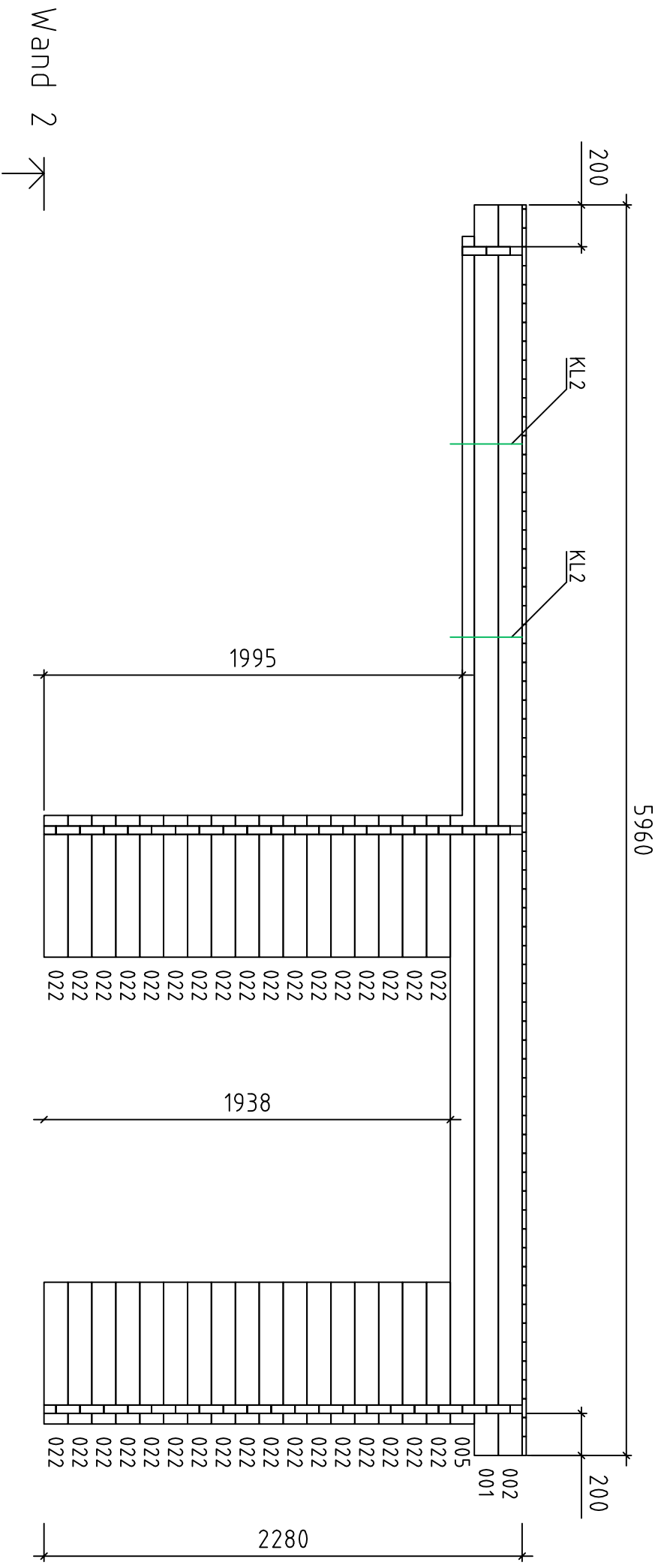

Wand 2



3031 Z / 40 / 2013

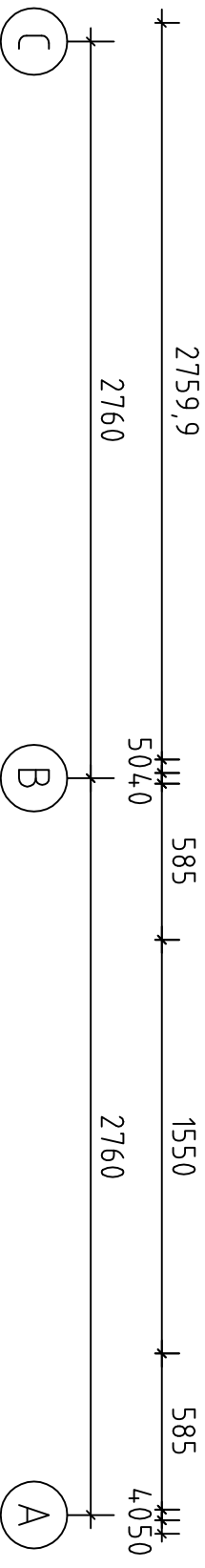

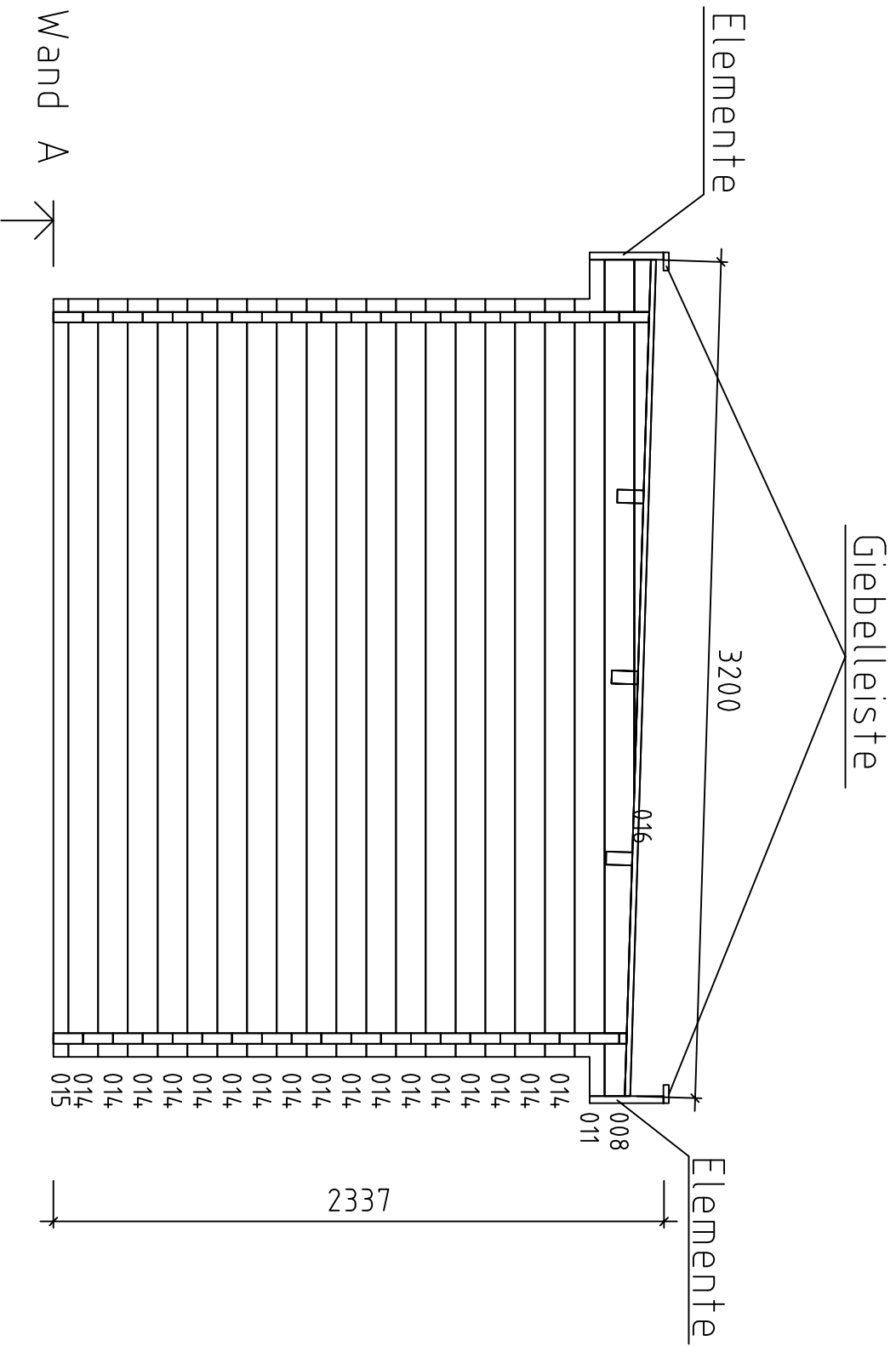

3031 Z / 40 / 2013

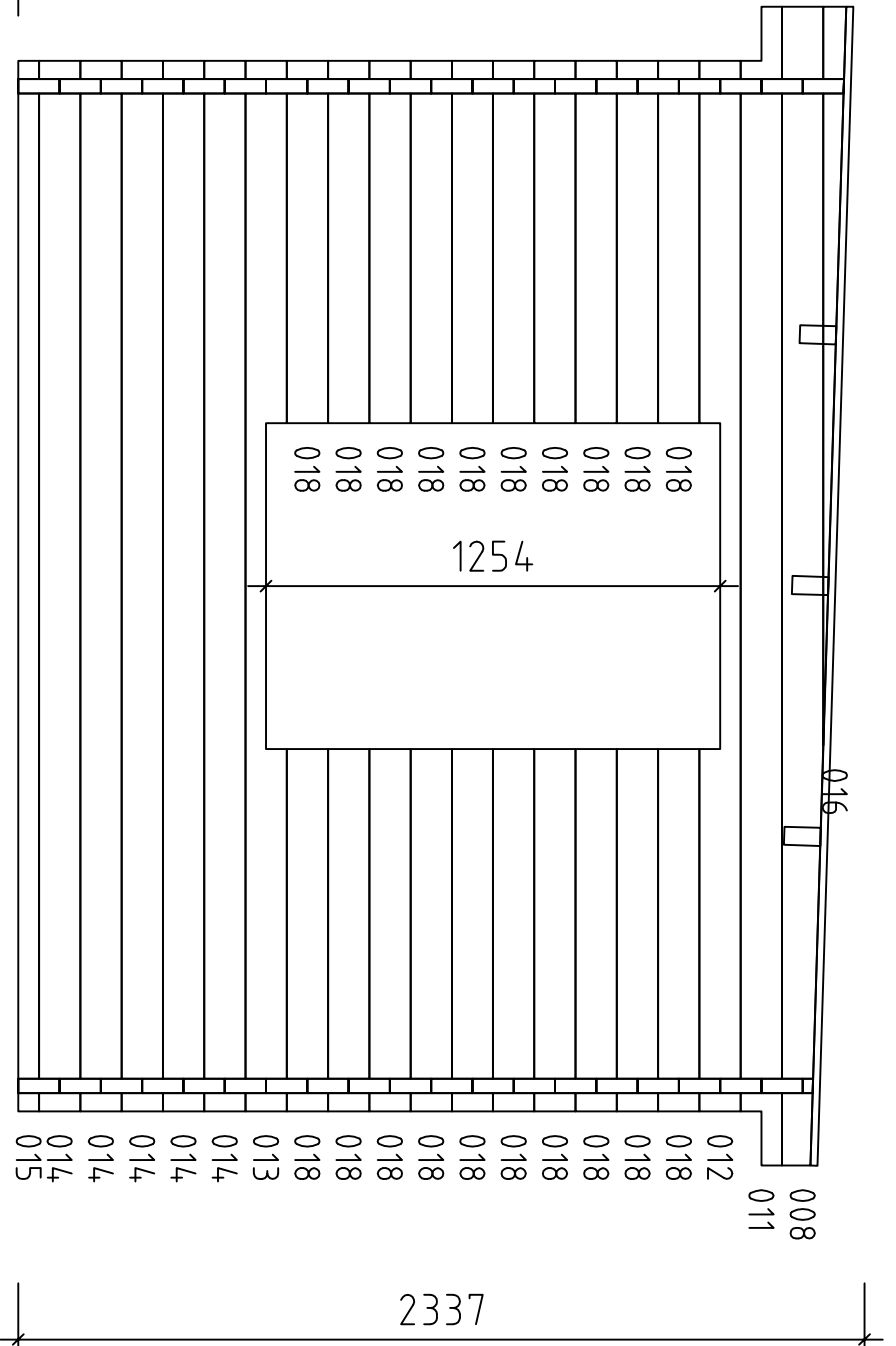

Wand B

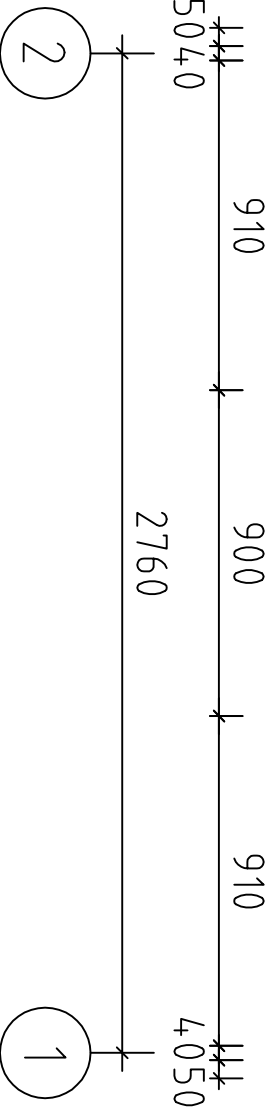



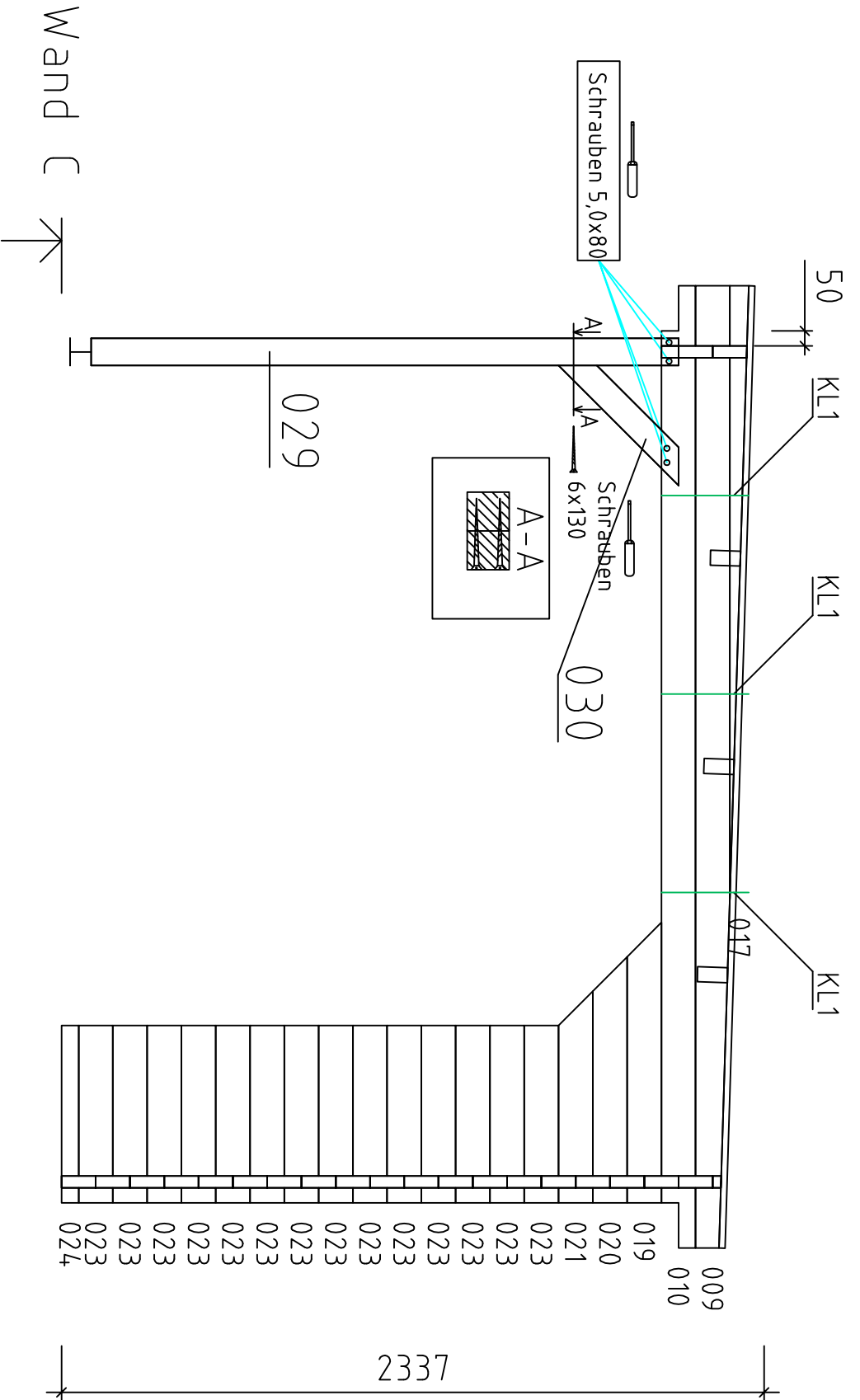





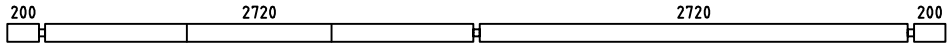

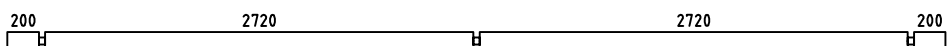

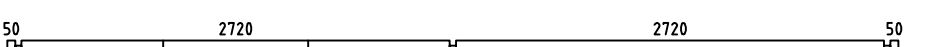
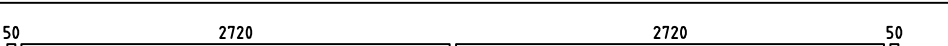
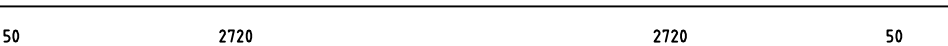
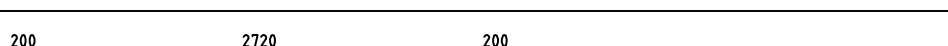
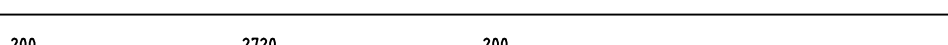
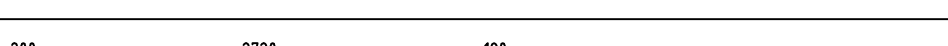
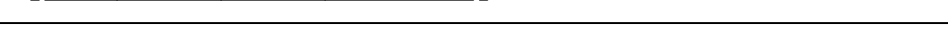
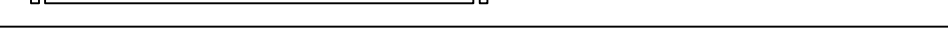
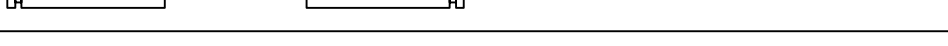
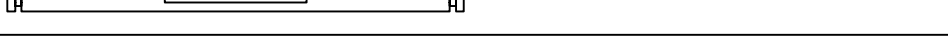
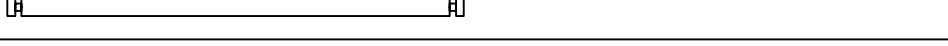
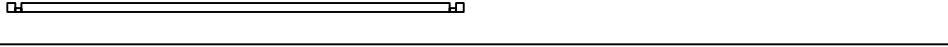

3031 Z / 40 / 2013











3031Z / 40 / 2013

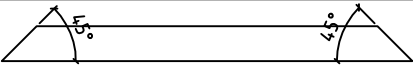
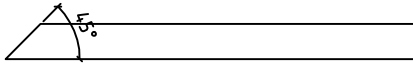

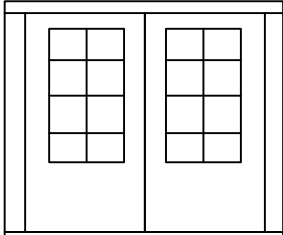
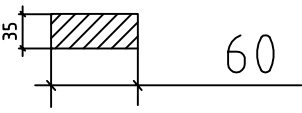
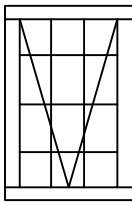
Pos	3031 Z / 40 / 2013	ST	F (mm)	L (mm)
001		1	40x114	5960
002		1	40x114	5960
003		1	40x114	5960
004		1	40x29	5960
005		1	40x114	5660
006		1	40x114	5660
007		17	40x114	5660
008		2	40x114	3200
009		1	40x114	3200
010		1	40x114	3200
011		2	40x114	3200
012		1	40x114	2900
013		1	40x114	2900
014		22	40x114	2900
015		2	40x57	2900
016		2	40x63	2040
017		1	40x63	2040
018		20	40x114	1000
019		1	40x114	932
020		1	40x114	818
021		1	40x114	704
022		34	40x114	675
023		14	40x114	590
024		1	40x57	590
PR1		3	50x140	5960

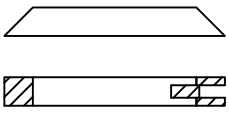
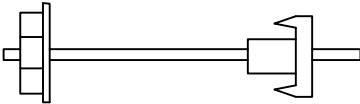
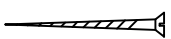

Pos	3031 Z / 40 / 2013		ST	F (mm)	L (mm)
KT1	Karnieseträger		8	50x140	200
vÖ1	Elemente		2	28x270	3220
vÖ2			2+2	28x270	3008
HL1	Giebelleiste		2	90x20	3256
HL2			4	90x20	3008
025	Dachbretter		67	90x20	3200
026	Abdeckleiste			20x40	20m
027	Tür 1550x1938	 <p>all piirdelauda ei ole Klaas 536x1062 2tk Roostevaba plekk 1446x60</p> 	1		
028	Fenster 900x1254	 <p>Klaas 727x1062</p>	1		
029	Pfosten		1	90x90	2022
030	Träger		1	90x90	564
G1	Gewindesttift		5	90x90	310
031	Schrauben		10	5,0x80	
032	Schrauben		2	6,0x130	

# 3031 Z / 40 / 2013

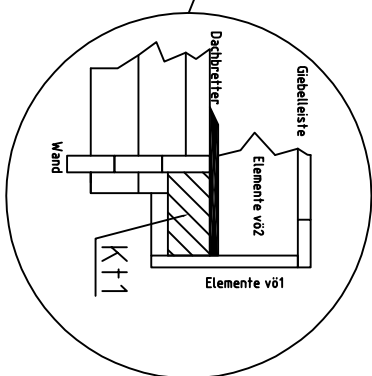
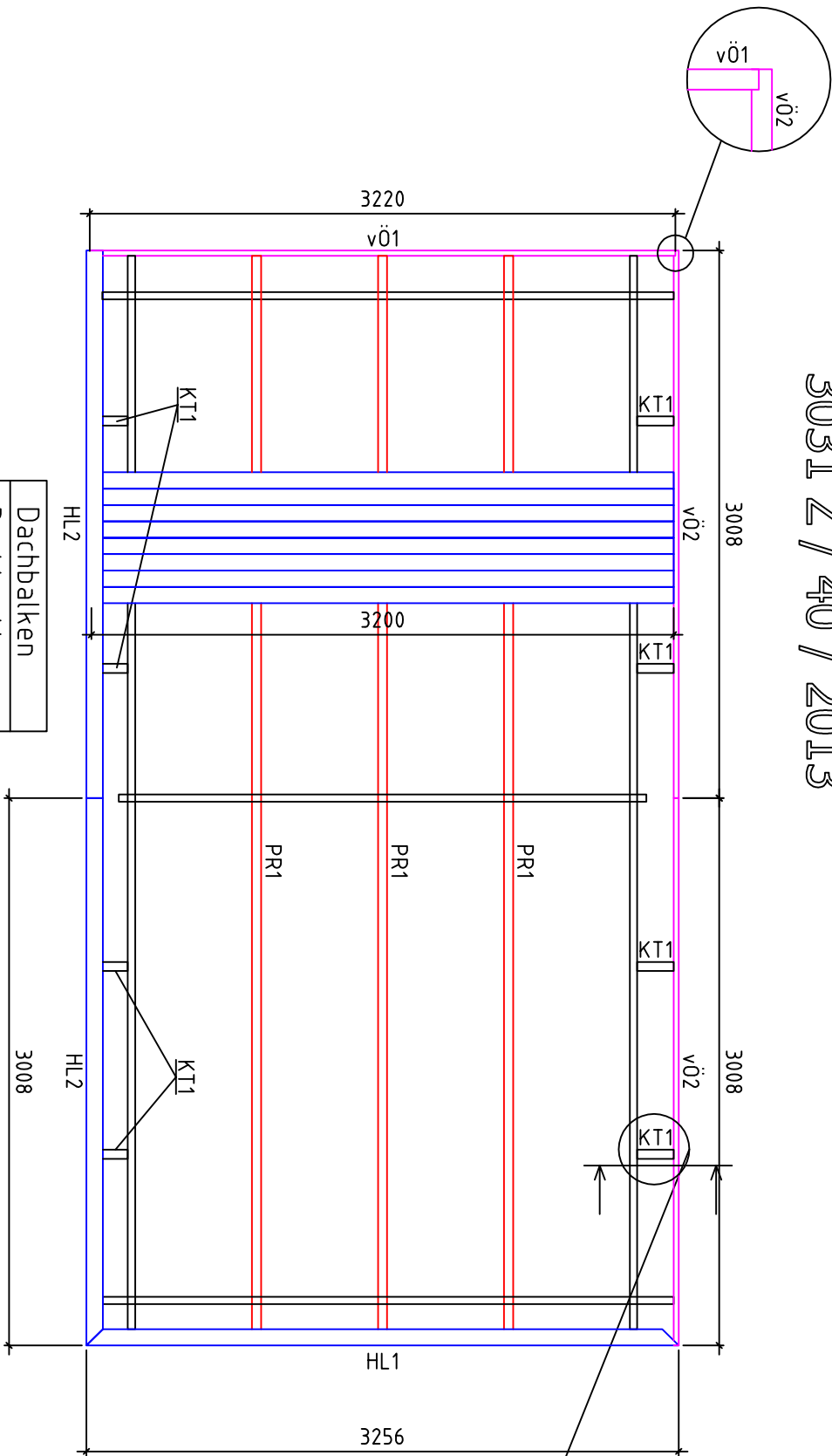

Dachbalken
Dachbretter
Karnieseträger
Elemente
Giebelleiste

# Doppeltür

Beschlag:

Türklinen mit der Lasche = 1 Kmp.

Schraube 5x80mm = 4 St.

Schnepper mit Schlüsseln = 1 Kmp.

Metalblechen (zwei St.)

Pos. 5, befinden sich auf  
untere oder obere  
Türflügelkante.

Schrauben 5x80

Schrauben 5x80

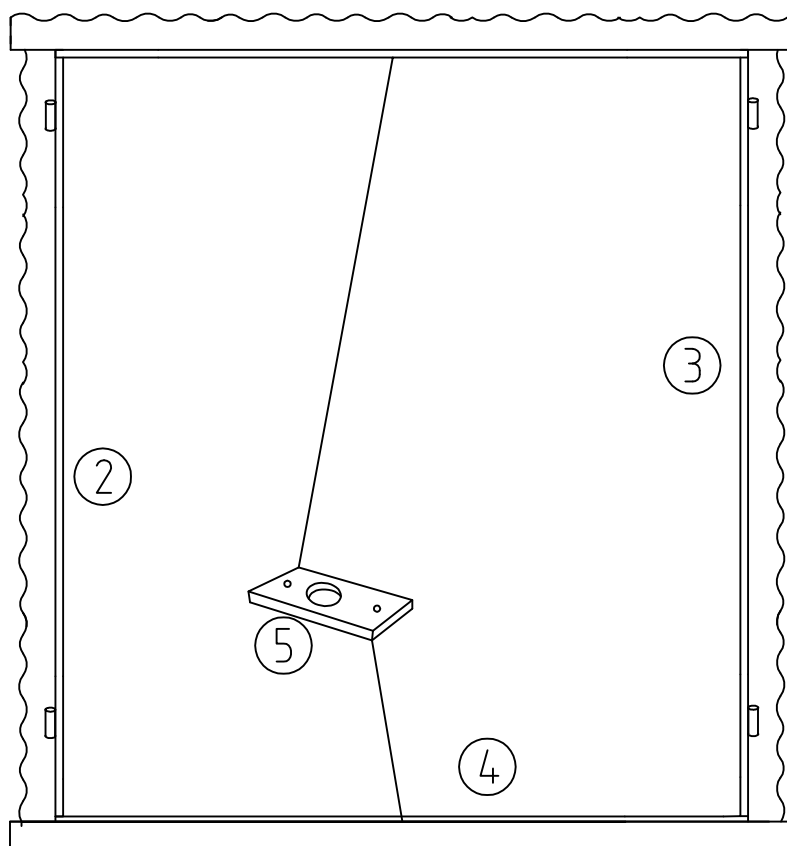

Schrauben 5x80

Schrauben 5x80