

3026 / 28 / 22

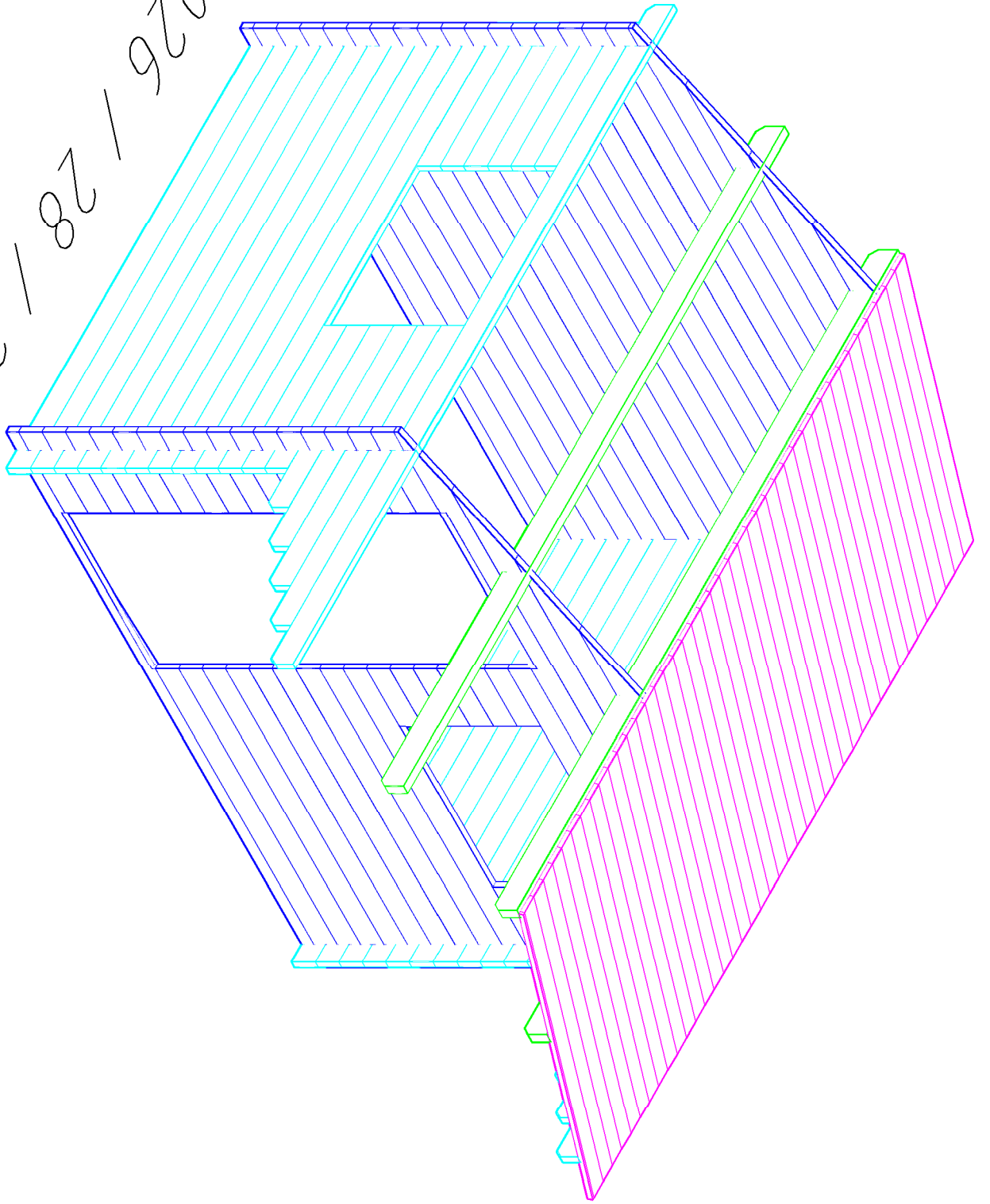

3026 / 28 / 22

2300

2244

2800

2744

A

B

3

1

90x67

88x187

90x67

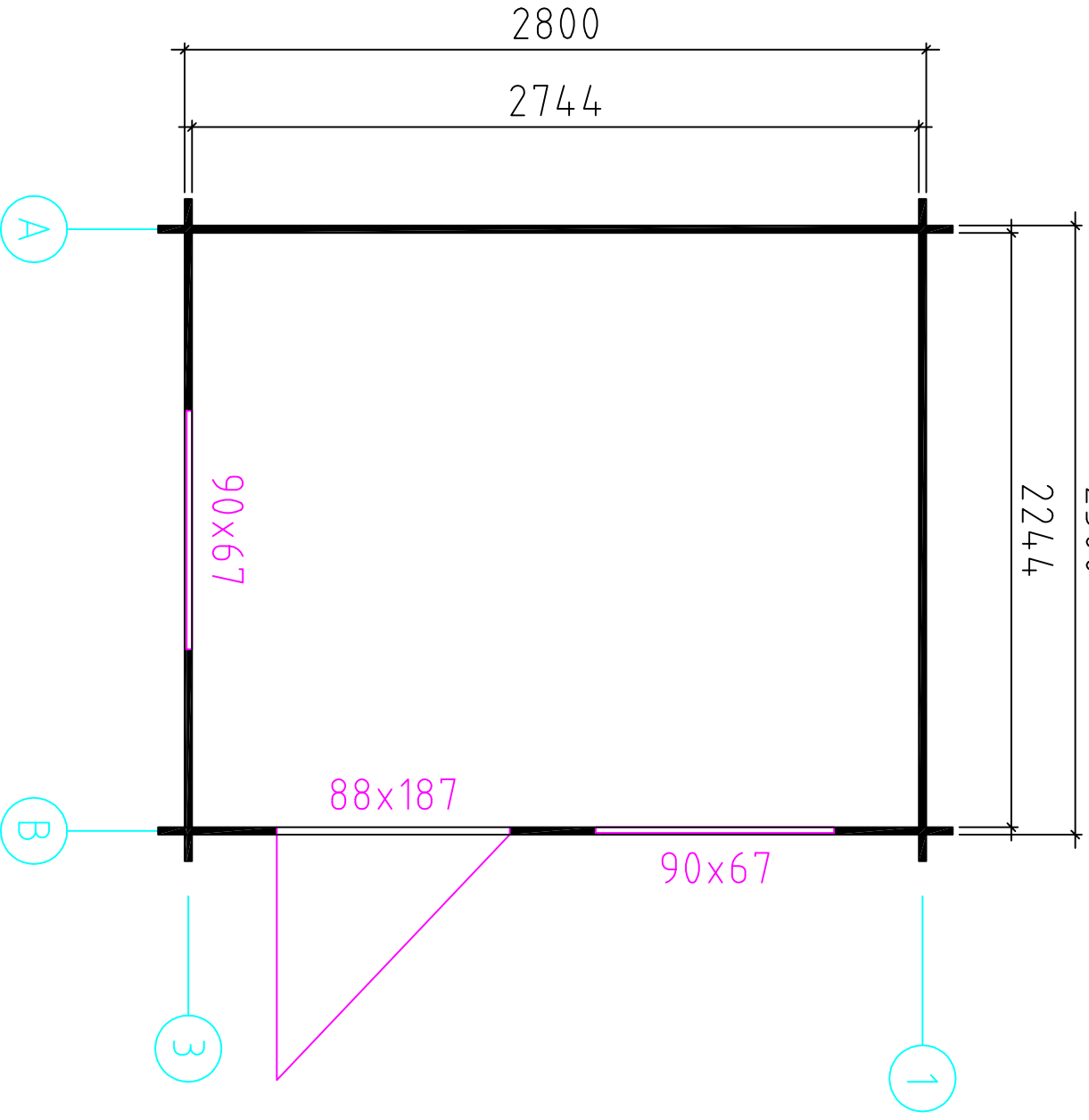

Wand 1 ↗

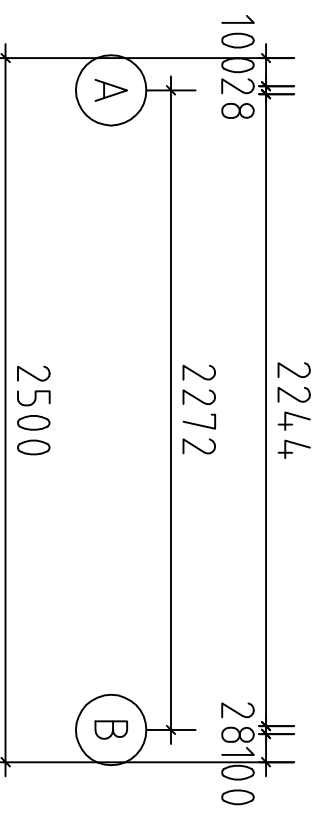
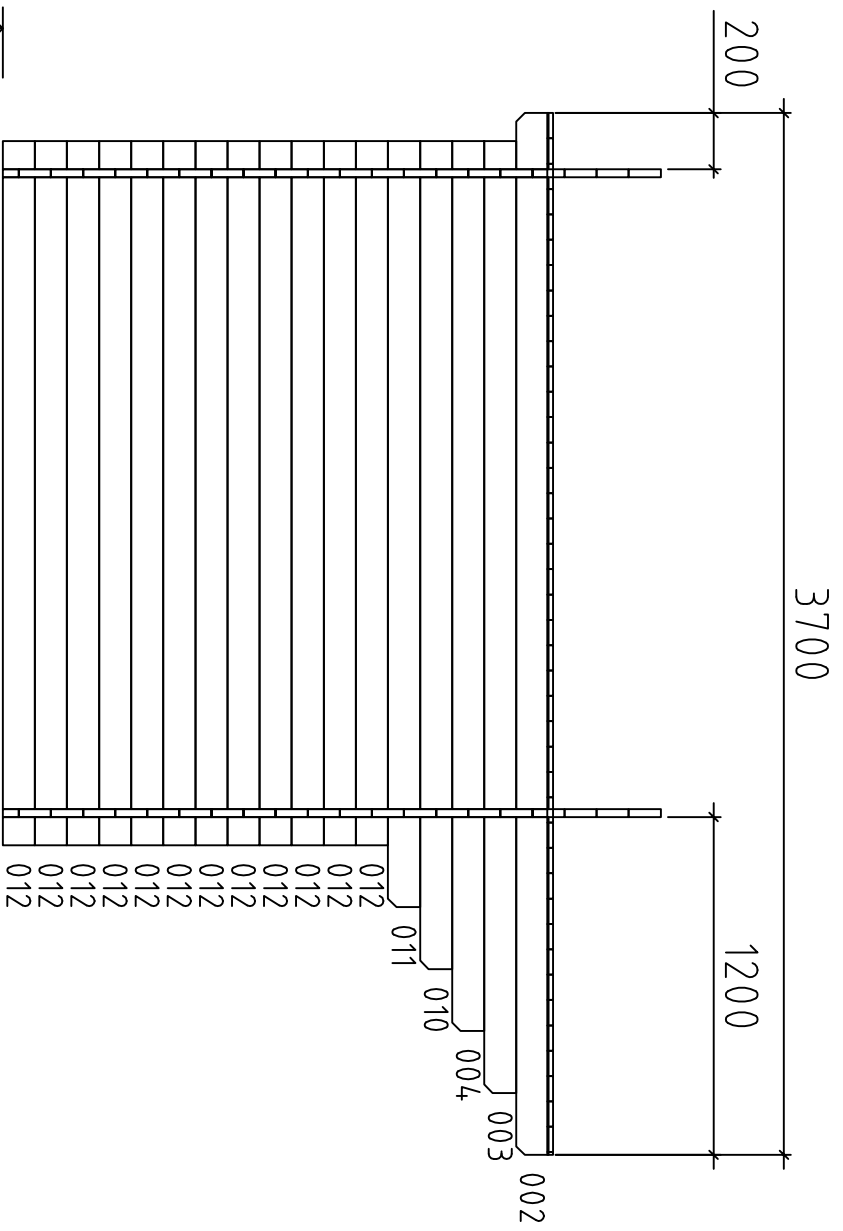

3026 / 28 / 22

Wand 3 ↗

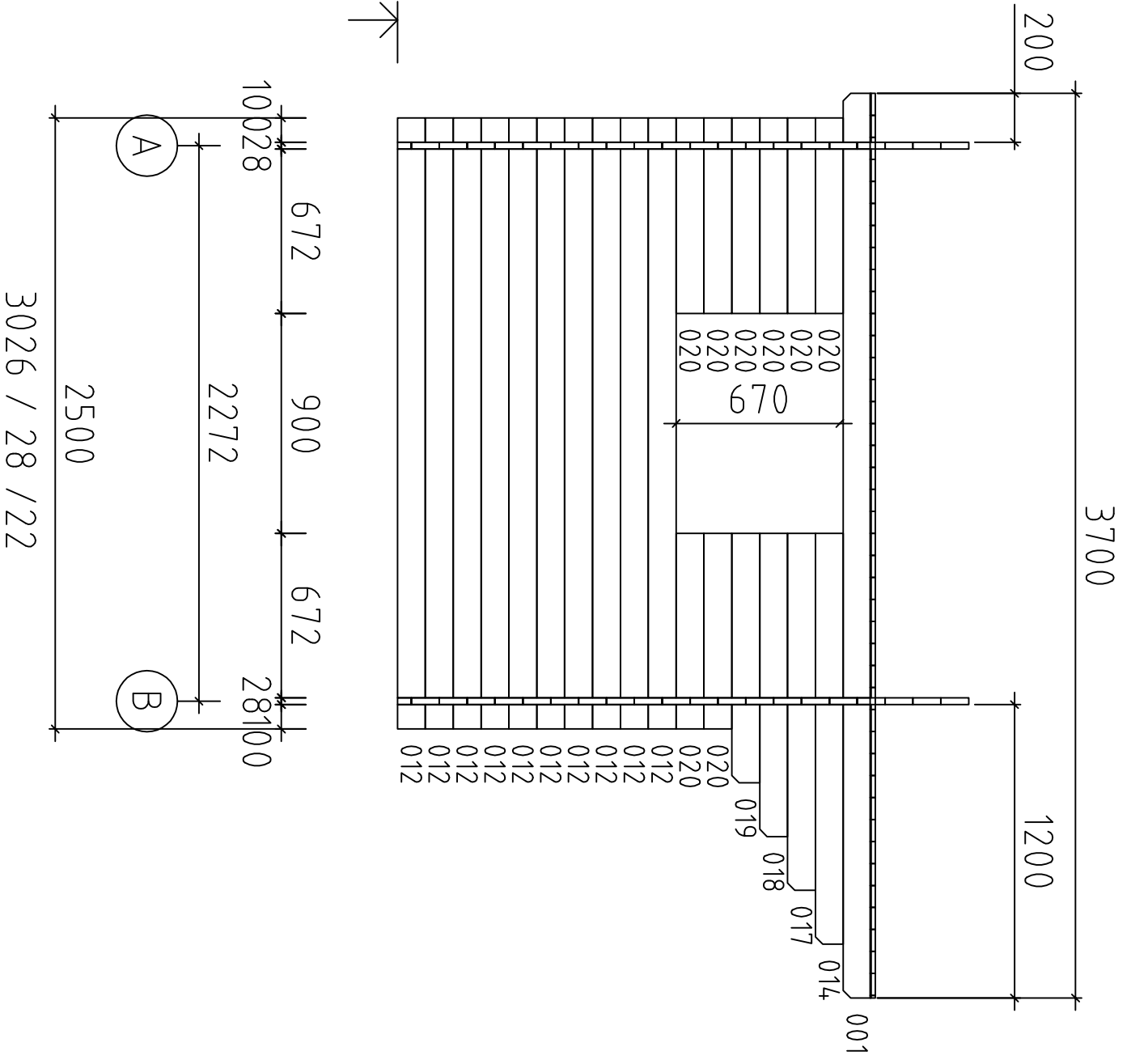

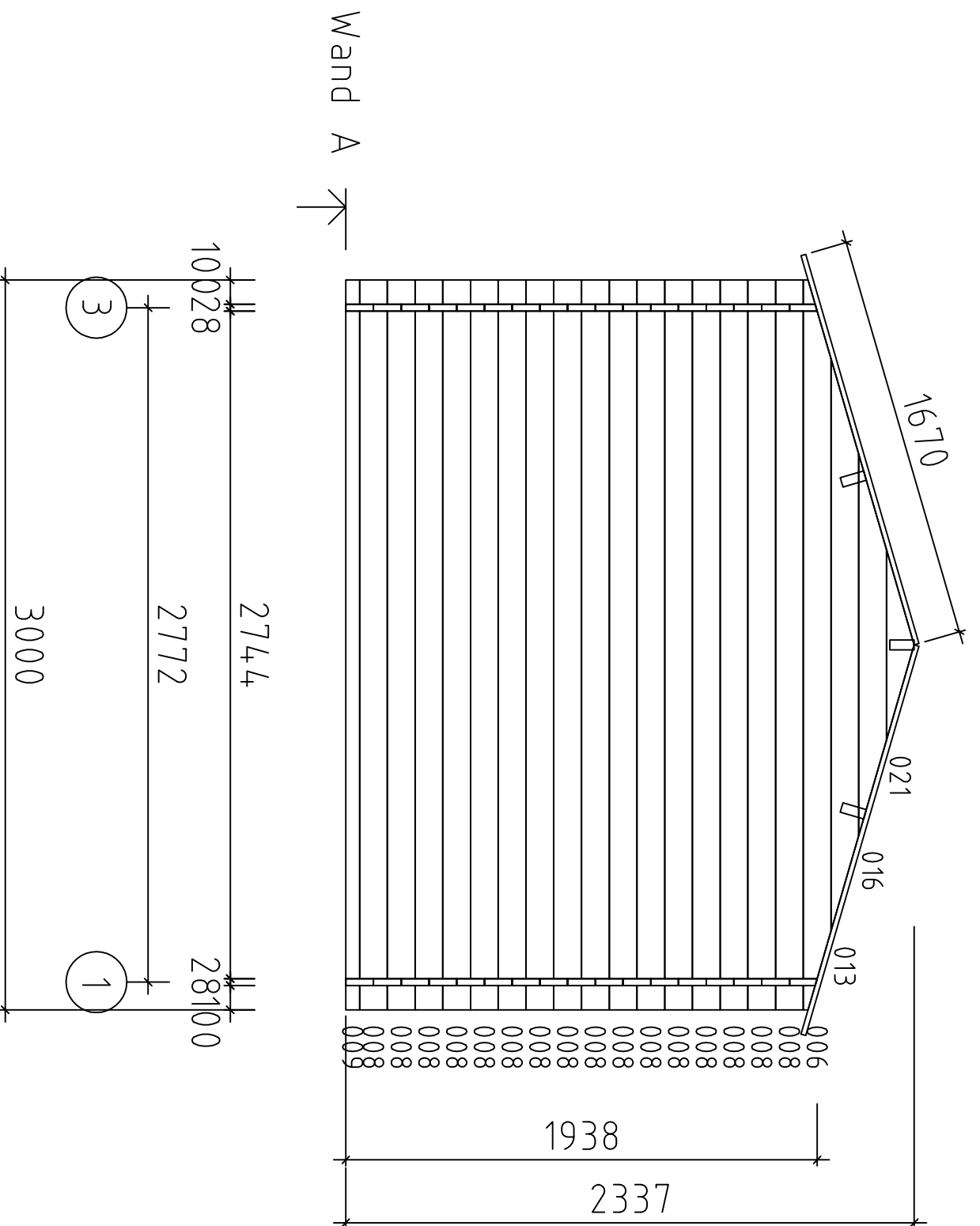

3026 / 28 / 22

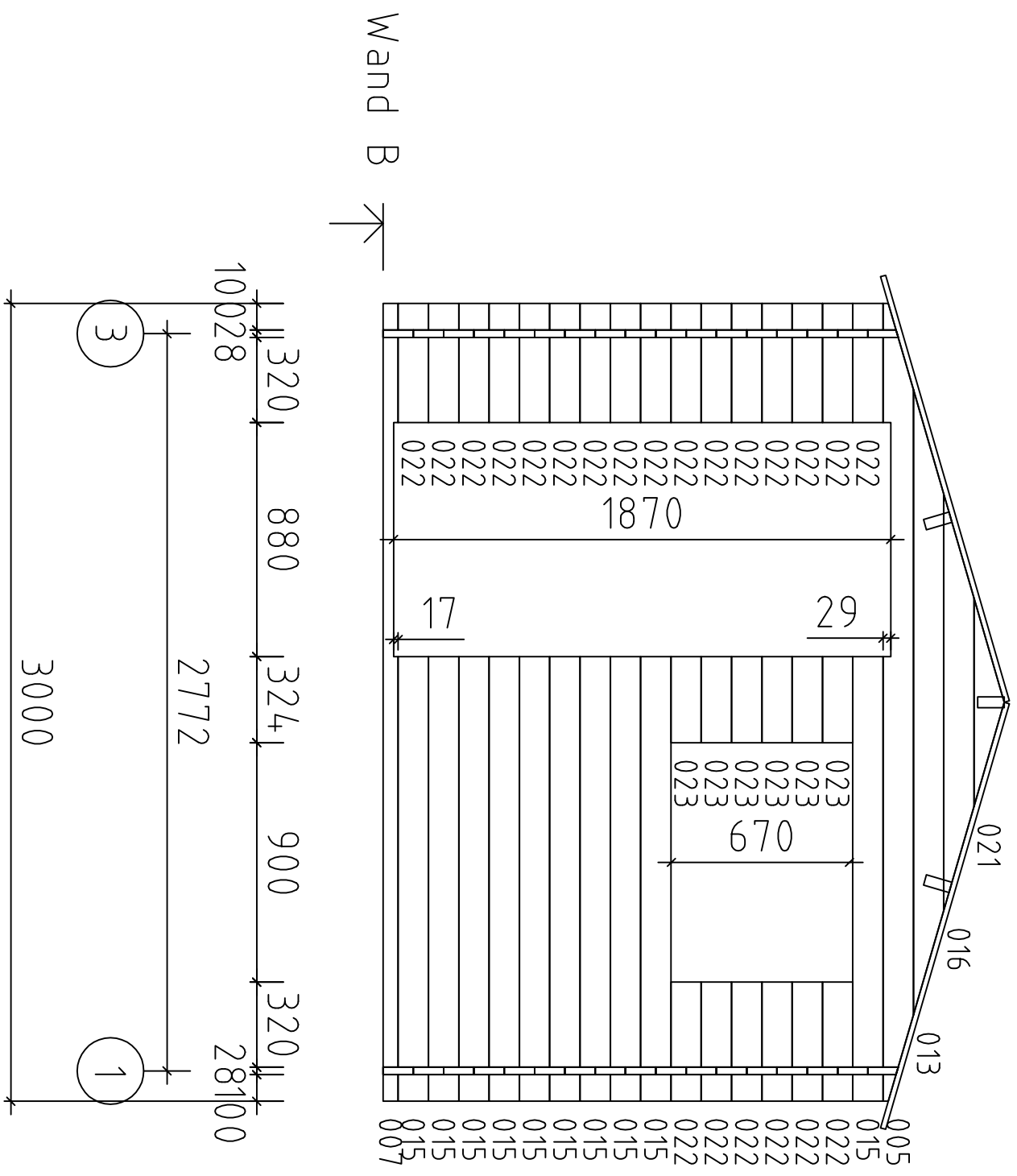

Wand B

3026 / 28 / 22

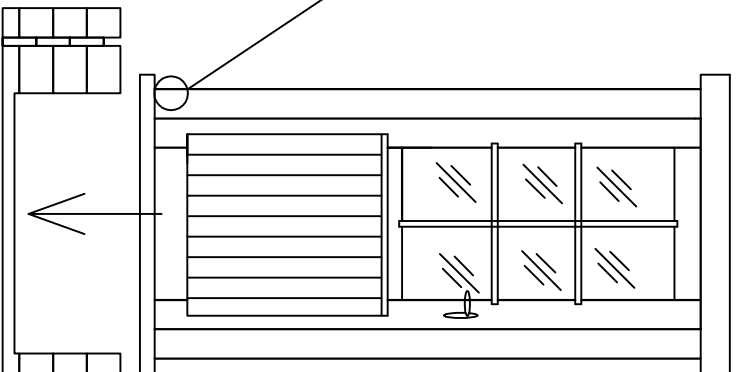
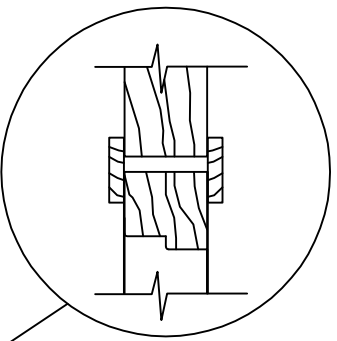



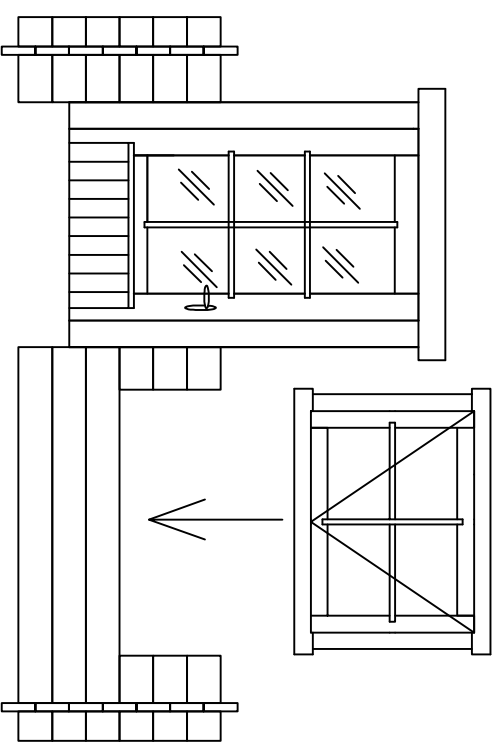



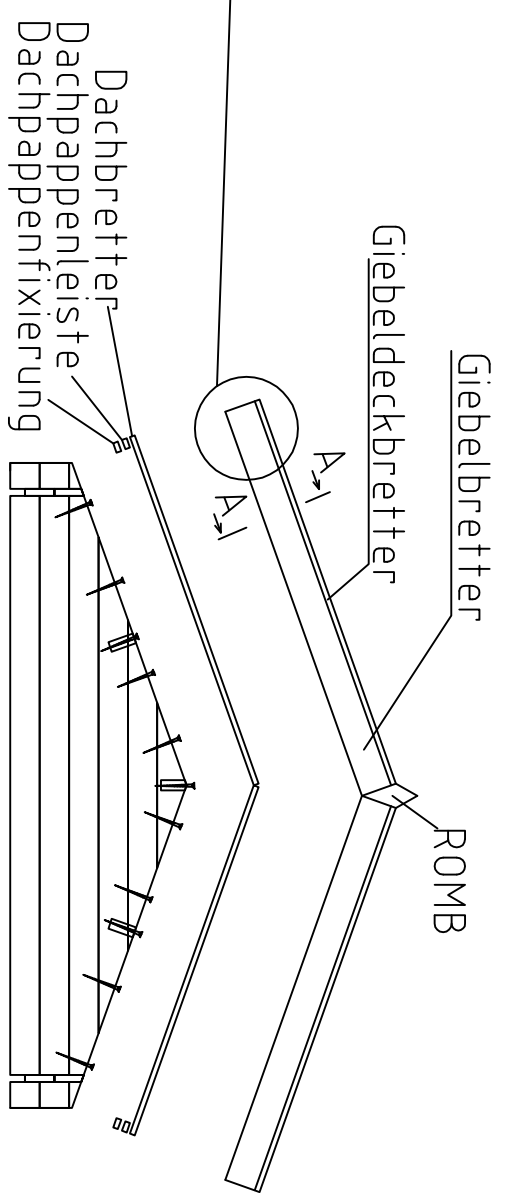
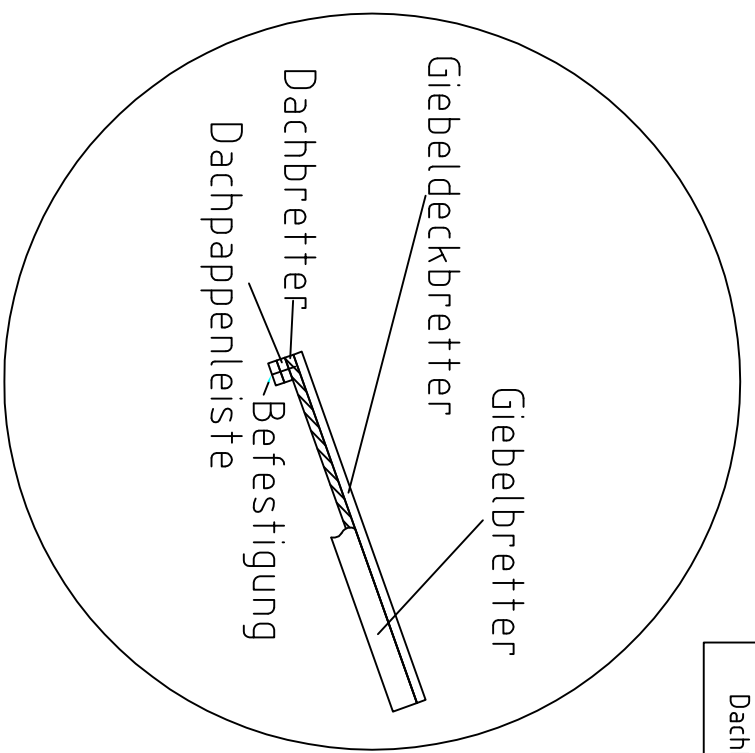
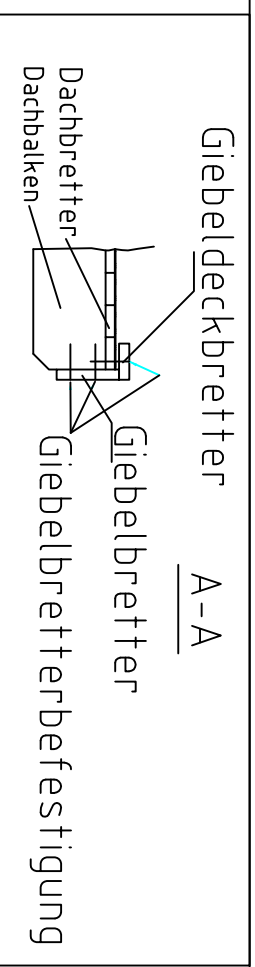

Den Einbau den
Türen sollten Sie
nach der 5-6
Bohlenschicht
vornehmen!!!

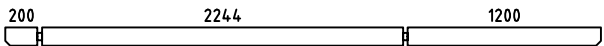
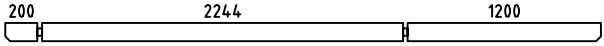
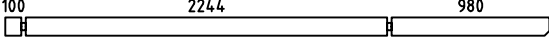
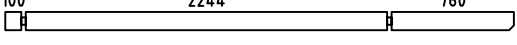
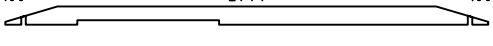
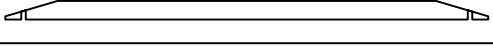
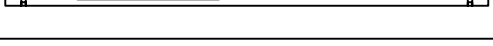
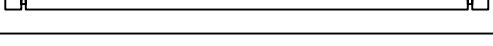
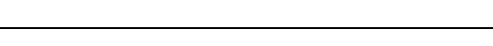
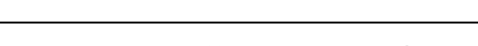
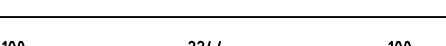
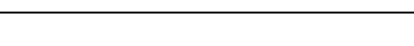
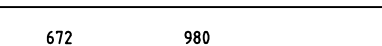
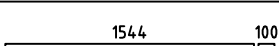

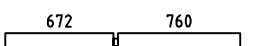
3026 / 28 / 22

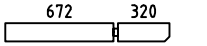
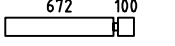
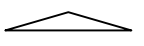
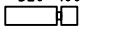

3026 / 28 / 22

Pos	3026 / 28 / 22	ST	F (mm)	L (mm)
001		1	28x114	3700
002		1	28x114	3700
003		1	28x114	3380
004		1	28x114	3160
005		1	28x114	3000
006		1	28x114	3000
007		1	28x57	3000
008		16	28x114	3000
009		1	28x57	3000
010		1	28x114	2940
011		1	28x114	2720
012		22	28x114	2500
013		2	28x114	2352
014		1	28x114	1680
015		10	28x114	1672
016		2	28x114	1568
017		1	28x114	1460
018		1	28x114	1240
019		1	28x114	1020
020		8	28x114	800
021		2	28x114	784
022		22	28x114	448
023		6	28x114	324
PR1		3	50x140	3700

